

LA CROSSE® TECHNOLOGY

WIRELESS TEMPERATURE & HUMIDITY STATION COMBO PACK INSTRUCTION MANUAL



MODELS: 308-1415TH / TX141TH-BV2 / 308-1409TH
DC: 071618

FIND MANUALS, FAQs, AND MORE UNDER THE
SUPPORT TAB HERE: bit.ly/m82738

TABLE OF CONTENTS

- [3. Power Up](#)
- [3. Color Display: LCD Features](#)
- [4. Settings Menu](#)
- [5. Adjustable Backlight](#)
- [6. Auto Dim Backlight](#)
- [6. HI/LO Temperature & Humidity Records](#)
- [7. Reset Temperature and Humidity Records](#)
- [7. Change Batteries](#)
- [8. Sensor Search](#)
- [8. Mini Display: LCD Features](#)
- [9. Settings Menu](#)
- [9. Change Batteries](#)
- [10. Sensor Search](#)
- [10. Sensor Weather Shield](#)
- [10. We're Here to Help!](#)
- [10. Join the Conversation](#)
- [11. Specifications](#)
- [11. Care and Maintenance](#)
- [12. Warranty Info](#)
- [12. FCC Statement](#)

POWER UP

1. Insert 2-AA batteries into your Outdoor Sensor.
2. Insert the 5 volt power cord into an outlet, then into your Color Display. Optional: Insert 2-AA batteries for backup.
3. Insert 2-AAA batteries into your Mini Display.
4. Adjust time and date settings on each display.
5. Once the Outdoor Sensor is reading to each of your displays, place it outside in a shaded location.

Watch sensor mounting video: http://bit.ly/TH_SensorMounting

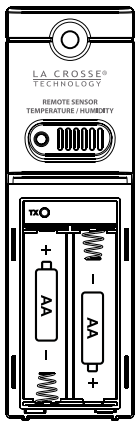

Outdoor Sensor
TX141TH-Bv2

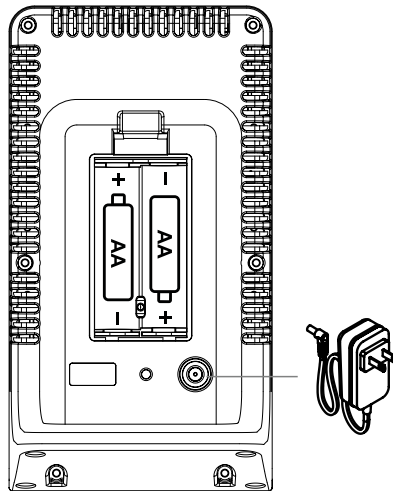

Color Display
308-1415TH

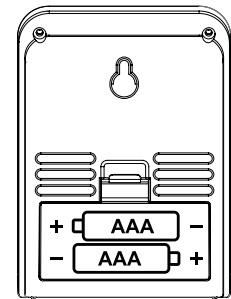

Mini Display
308-1409TH

COLOR DISPLAY: LCD FEATURES

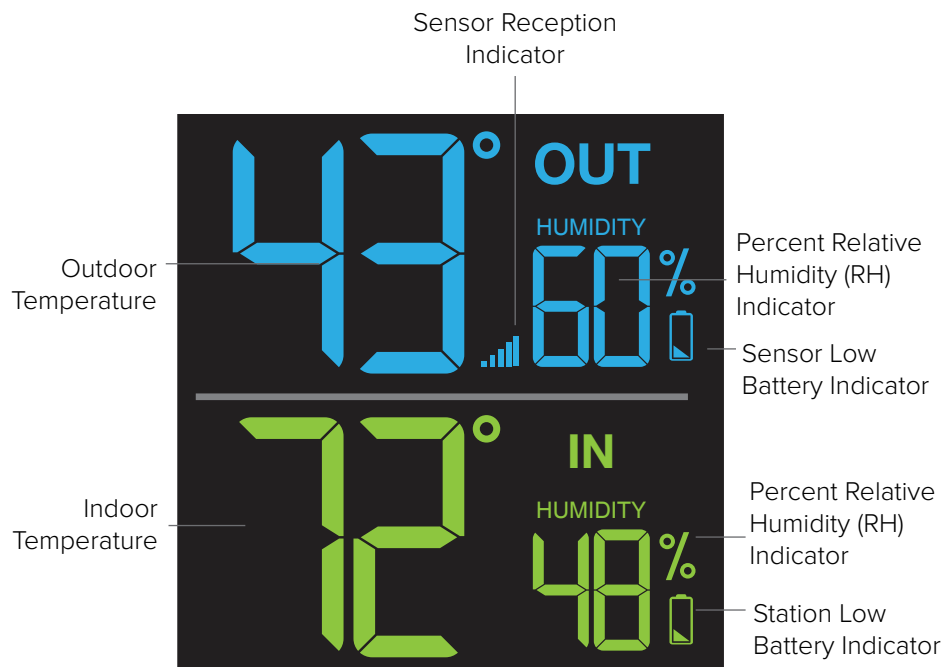

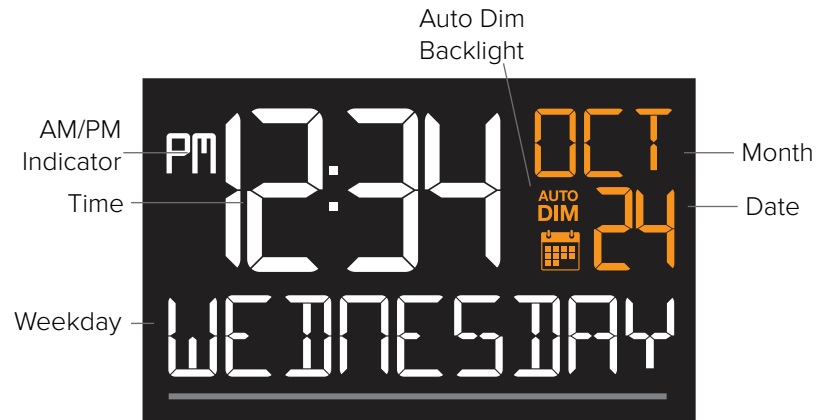

SETTINGS MENU

It is best to press one button at a time when setting your station.

1. Hold the SET button to enter the Settings Menu.
2. Press the + or - button to adjust the values. Hold to adjust quickly.
3. Press the SET button to confirm and move to the next item.
4. Press the LIGHT button to exit.

Settings Menu Order:

- Language (English, Spanish, French)
- Beep ON/OFF
- 12/24 Hour
- Hour
- Minutes
- Year
- Month
- Date
- Fahrenheit or Celsius

Note: When Spanish (Español), or French (Français) are selected, the rest of the instructions will be in that language.

Note: Your weekday will set automatically after year, month, and date are set.

1. Hold the SET button for 2 seconds to enter setting mode. ENGLISH will flash. Press the + or - button to select ESPANOL, or FRANCAIS.

Note: When Español or Français are selected, the reset of the menu items will be in that language.

2. Press SET to confirm and move to beep sound. BEEP ON will show. ON flashes. Press the + or - button to turn the button beep sound off.

3. Press SET to confirm and move to 12/24 hour time format. 12Hr FORMAT will show. 12HR flashes. Press the + or - button to turn select 24 hour time format. Press SET to confirm and move to the hour. HOUR will show. The hour flashes. Press the + or - button to choose the hour.

4. Press SET to confirm and move to the minutes. The MINUTES will show. Minutes flash. Press the + or - button to choose the minutes.

5. Press SET to confirm and move to the year. The YEAR 2018 will show. Year will flash. Press the + or - button to change the year.

6. Press SET to confirm and move to the month. The MONTH will flash. Press the + or - button to change the month.

7. Press SET to confirm and move to the date. DATE will flash. Press the + or - button to change the date.

8. Press SET to confirm and move to the temperature unit. TEMP °F will show. °F will flash. Press the + or - button if you prefer °C (Celsius).

9. Press SET to confirm and exit.

Note: After 10 seconds with no button press, your station returns to normal time display.

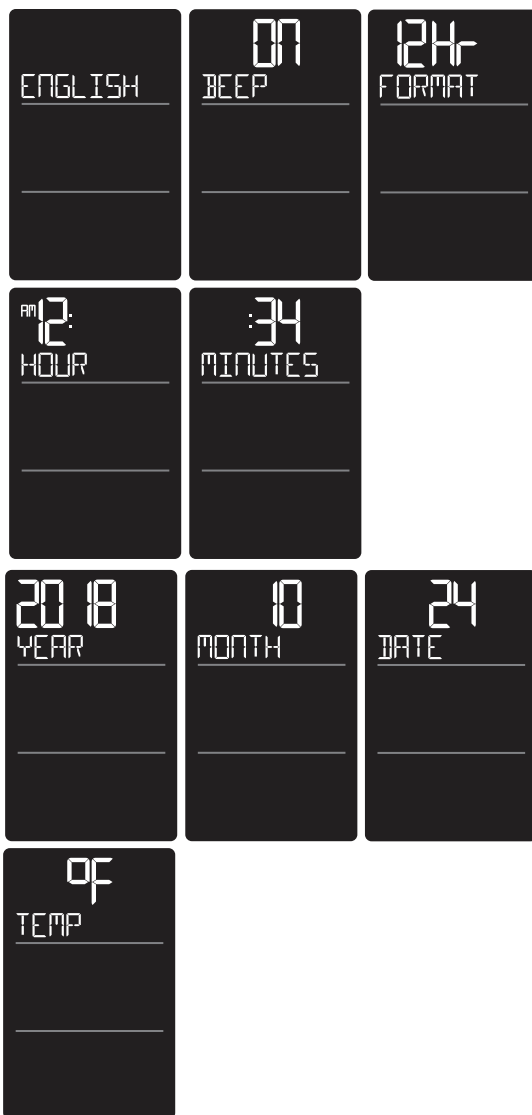

ADJUSTABLE BACKLIGHT

Your Backlight may be turned OFF and adjusted to 4 levels of brightness.

To adjust brightness:

1. Press and release the LIGHT button to adjust backlight brightness.
2. The word BACKLIGHT and the setting will show.
3. Once you have the desired backlight brightness, stop pressing buttons.



AUTO DIM BACKLIGHT

This station allows you to program a time for the backlight to automatically Dim to level one setting. This way the station will not interfere with your sleep.

Setup Auto Dim:

1. Hold the LIGHT button to set Auto Dim Start and Stop times.
2. Use the + or - button to turn the Auto Dim feature ON. Press the LIGHT button to confirm and move to next item.
3. START TIME will flash. Use the + or - buttons to select your Auto Dimmer's starting hour. Press the LIGHT button to confirm and move to next item.
4. STOP TIME will flash. Use the + or - buttons to select your Auto Dimmer's ending hour. Press the LIGHT button to confirm and exit.

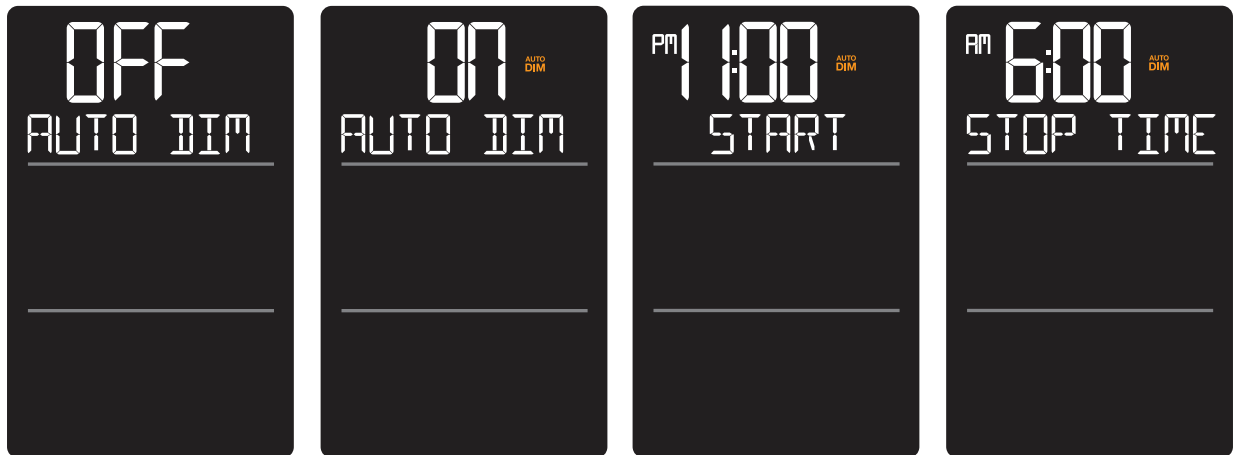

Note: While the Auto Dim is active, if you press the LIGHT button, the backlight will change to the brightness level selected and stay there. Auto Dim will resume at the next scheduled time.

HI/LO TEMPERATURE & HUMIDITY RECORDS

The HI & LO temperature and humidity readings are recorded with time and date of occurrence. This provides a running history of records since you first power up the station. Each time a new high or low reading is recorded, that reading with time and date of occurrence will show.

To view your HI or LO records, simply press and release the PLUS (+) button.

- Outdoor HI Temperature
- Outdoor LO Temperature

- Outdoor HI Humidity
- Outdoor LO Humidity

- Indoor HI Temperature
- Indoor LO Temperature

- Indoor HI Humidity
- Indoor LO Humidity



Outdoor Temperature Records

Outdoor Humidity Records

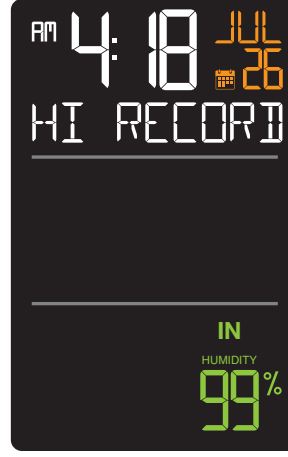

Indoor Temperature Records

Indoor Humidity Records

RESET TEMPERATURE AND HUMIDITY RECORDS

Your temperature and humidity readings are reset individually.

1. Press and release the PLUS (+) button to view the reading you wish to reset.
2. Hold the MINUS (-) button for 3 seconds to reset individual temperature or humidity value to current temperature, humidity, time and date. Press the PLUS (+) button to move to the next value.
3. Press and release the LIGHT button to exit.

CHANGE BATTERIES

We designed this station for convenience, so that a simple change of batteries does not lose your data or require you to power down your station.

Sensor:

1. When Battery Indicator shows next to the Outdoor Humidity, replace batteries in your Outdoor Sensor.
2. Then hold the PLUS (+) button for 3 seconds and your station will search for your sensor.

Station:

1. When Battery Indicator shows next to the Indoor Humidity, change batteries in the station.
2. When changing the batteries in the station, continue using the power cord. After replacing the batteries, no other action is needed. The batteries in the station only maintain time/date in the event of a power outage.

SENSOR SEARCH

- If you are seeing dashes in place of outdoor temperature, first check your sensor batteries.
- Hold the PLUS (+) button for 3 seconds to search for the sensor. Sensor Reception icon will flash while searching and be solid when sensor signal is received.
- If you regain connection while the sensor is mounted, great. If you do not regain connection, bring the sensor within 10 feet of the station and search again.

Note:

- If the signal is lost, the RX will display the last data recorded from sensor for 10 minutes.
- After that 10 minutes if the signal does not come back then you will see dashes "--".
- After 30 minutes, start looking for the sensor signal automatically.

MINI DISPLAY: LCD FEATURES

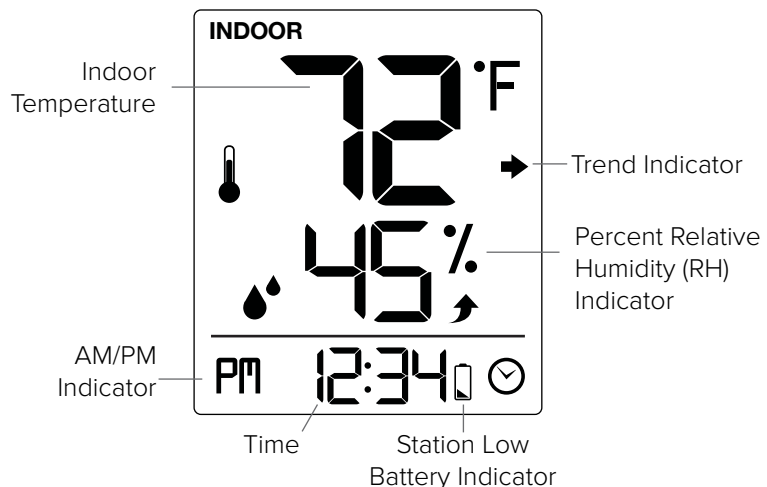
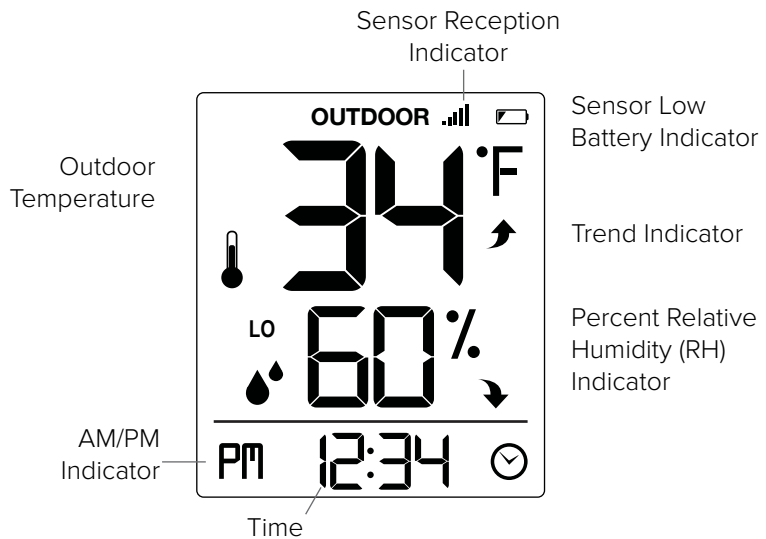

Press and release the SET/IN-OUT button to view Indoor Temp/Humidity or Outdoor Temp/Humidity.

SETTINGS MENU

1. Press and release SET/IN-OUT button to move to next item
2. Press and release +/SEARCH button to increase settings
3. Hold +/Search to adjust quickly

Setting order:

- 12/24 Hour Time
- Hour
- Minutes
- Fahrenheit/Celsius

1. Hold the SET/IN-OUT button for 3 seconds. 12Hr will flash. Press and release the +/SEARCH button if you want 24 hour time.
2. Press and release SET/IN-OUT to confirm and the hour will flash. Press and release the +/SEARCH button to set the hour.
3. Press and release SET/IN-OUT to confirm and the minutes will flash. Press and release the +/SEARCH button set the minutes.
4. Press and release SET/IN-OUT to confirm and °F (Fahrenheit) will flash. Press and release the +/SEARCH button if you want Celsius.
5. Press and release SET/IN-OUT to confirm and exit.

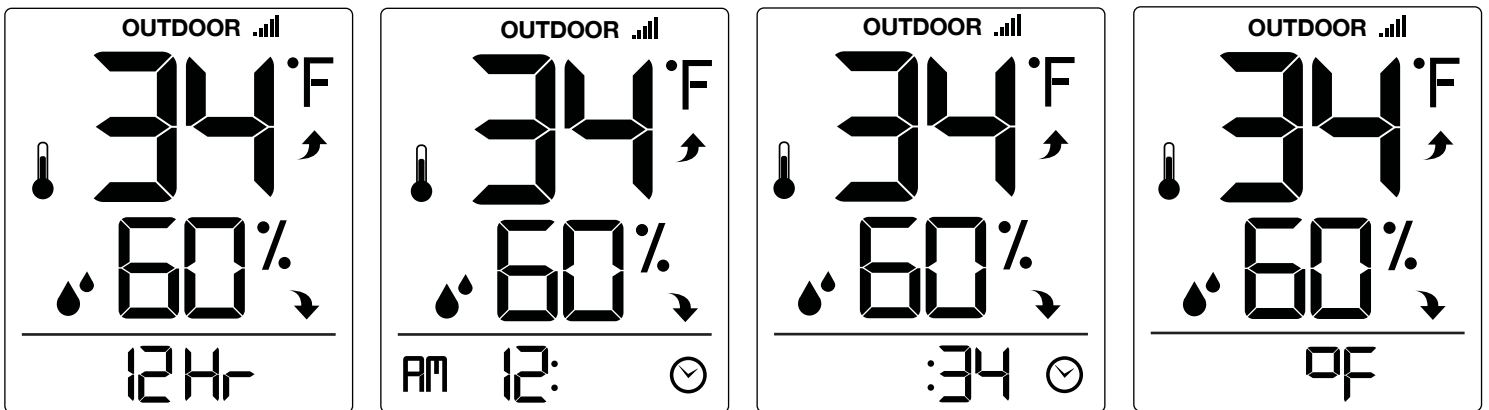

CHANGE BATTERIES

We designed this station for convenience, so that a simple change of batteries does not lose your data or require you to power down your station.

Sensor:

1. When Battery Indicator shows n the Outdoor section, replace batteries in your Outdoor Sensor.
2. Then hold the +/SEARCH button for 3 seconds and your station will search for your sensor.

Station:

1. When Battery Indicator shows next to the Time, change batteries in the station.
2. When changing the batteries in the station, continue using the power cord. After replacing the batteries, no other action is needed. The batteries in the station only maintain time/date in the event of a power outage.

SENSOR SEARCH

- If you are seeing dashes in place of outdoor temperature, first check your sensor batteries.
- Hold the +/SEARCH button for 3 seconds to search for the sensor. Sensor Reception icon will flash while searching and be solid when sensor signal is received.
- If you regain connection while the sensor is mounted, great. If you do not regain connection, bring the sensor within 10 feet of the station and search again.

Note:

- If the signal is lost, the RX will display the last data recorded from sensor for 10 minutes.
- After that 10 minutes if the signal does not come back then you will see dashes "--".
- After 30 minutes, start looking for the sensor signal automatically.

SENSOR WEATHER SHIELD-NOT INCLUDED

The Sensor Weather Shield is designed to protect your outdoor sensor from rain and snow. This shield will offer limited protection from the sun's heat. Purchase at: <http://bit.ly/925-1418>



WE'RE HERE TO HELP!

If you require additional support, call our customer support team based out of La Crosse, Wisconsin.

Phone: 1.608-782-1610

Or fill out our online support request form here: bit.ly/contact_techsupport

Our knowledgeable support team is available: Monday-Friday, 8am-6pm CST

JOIN THE CONVERSATION

Ask questions, watch detailed setup videos, and provide feedback on our social media outlets!



SPECIFICATIONS

Indoor:

Temperature Range: 32°F to 122°F (0°C to 50°C)

Humidity Range: 10% to 99% RH

Outdoor:

Temperature Range: -40°F to 140°F (-40°C to 60°C)

Humidity Range: 10% to 99% RH

Transmission Range: over 330 feet (100 meters) in open air RF 433MHz

Power Requirements:

308-1415TH: AC6: GPU280500150WA00 (required)

Optional: 2 "AA" LR6 Batteries (not included)

308-1409TH: 2 "AAA" LR3 Batteries (not included)

TX141TH-Bv2: 2 "AA" LR6 Batteries (not included)

Battery Life:

308-1415TH: over 24 months with reputable batteries

308-1409TH: over 24 months with reputable batteries

TX141TH-Bv2: over 24 months with reputable batteries

Dimensions:

308-1415TH: 3.24" L x 2.16" W x 5.98" H (8.23cm L x 5.48cm W x 15.19cm H)

308-1409TH: 2.64" L x 1.32" W x 3.62" H (6.7cm L x 3.35cm W x 9.19cm H)

TX141TH-Bv2: 1.57" L x 0.82" W x 5.11" H (3.98cm L x 2.08cm W x 12.98cm H)

CARE AND MAINTENANCE

- Do not mix old and new batteries.
- Do not mix Alkaline, Standard, Lithium, or Rechargeable batteries.
- Always purchase the correct size and grade of battery most suitable for intended use.
- Replace all batteries of a set at the same time.
- Clean the battery contacts and also those of the device prior to battery installation.
- Ensure the batteries are installed with correct polarity (+ and -).
- Remove batteries from equipment which is not to be used for an extended period of time.
- Promptly remove expired batteries.

WARRANTY INFO

La Crosse Technology, Ltd. provides a **1-year limited time warranty** (from date of purchase) on this product relating to manufacturing defects in materials & workmanship.

For Full Warranty Details, Visit: www.lacrossetechnology.com/support

FCC STATEMENT

This equipment has been tested and found to comply with the limits for a Class B digital device, pursuant to part 15 of the FCC Rules. These limits are designed to provide reasonable protection against harmful interference in a residential installation. This equipment generates, uses and can radiate radio frequency energy and, if not installed and used in accordance with the instructions, may cause harmful interference to radio communications. However, there is no guarantee that interference will not occur in a particular installation. If this equipment does cause harmful interference to radio or television reception, which can be determined by turning the equipment off and on, the user is encouraged to try to correct the interference by one or more of the following measures:

- Reorient or relocate the receiving antenna.
- Increase the separation between the equipment and receiver.
- Connect the equipment into an outlet on a circuit different from that to which the receiver is connected.
- Consult the dealer or an experienced radio/TV technician for help.

This device must not be co-located or operating in conjunction with any other antenna or transmitter.

Operation is subject to the following two conditions:

- (1) This device may not cause harmful interference, and
- (2) This device must accept any interference received, including interference that may cause undesired operation.

Caution!

The manufacturer is not responsible for any radio or TV interference caused by unauthorized modifications to this equipment. Such modifications could void the user authority to operate the equipment.

All rights reserved. This manual may not be reproduced in any form, even in part, or duplicated or processed using electronic, mechanical or chemical process without the written permission of the publisher. This booklet may contain errors or misprints. The information it contains is regularly checked and corrections are included in subsequent editions. We disclaim any responsibility for any technical error or printing error, or their consequences.

All trademarks and patents are recognized.

⚠ WARNING: This product can expose you to chemicals including styrene, which is known to the State of California to cause cancer. For more information go to: www.P65Warnings.ca.gov